

(NO NEED TO PRINT THIS PAGE)

Instructions:

- A) First, have the child trace the SEQUENCE of pen strokes.
- B) Then have the child trace the words.
- C) Then have the child write the words freehand.

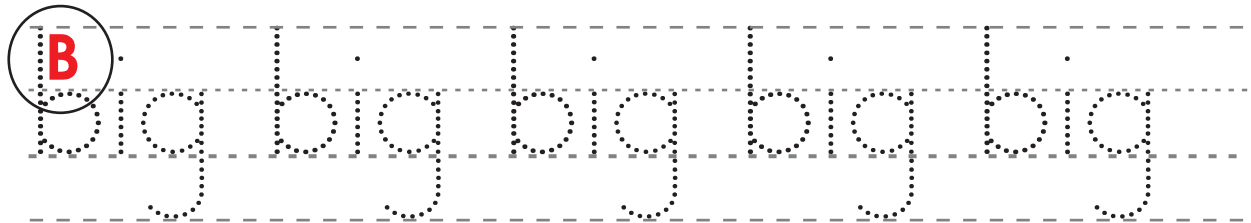

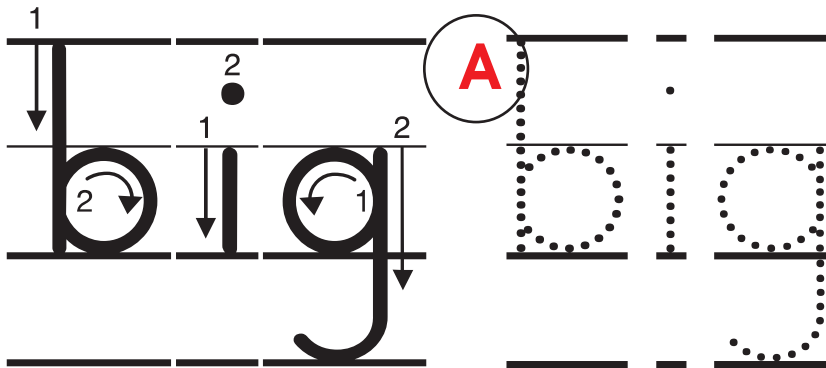
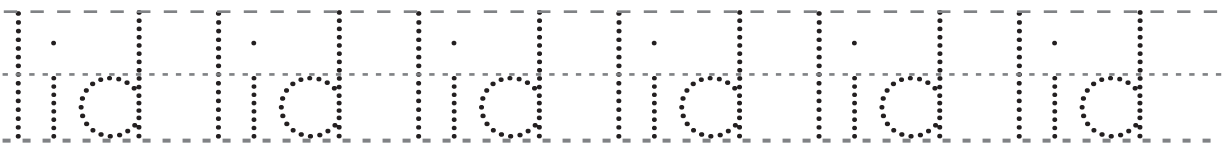
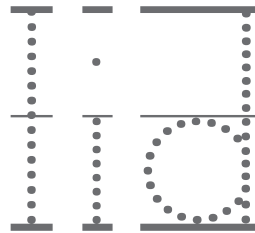
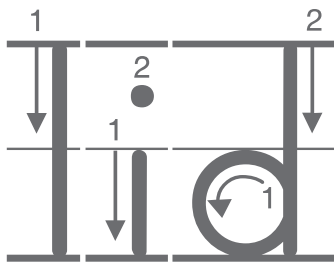
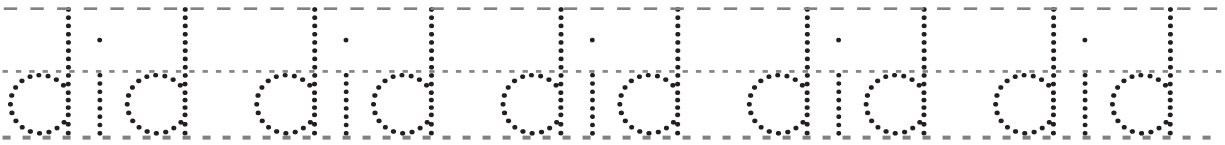
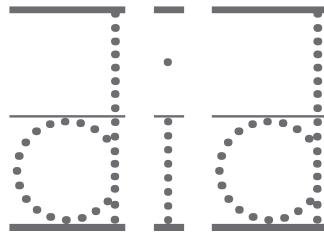
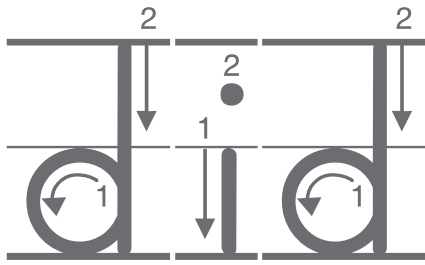

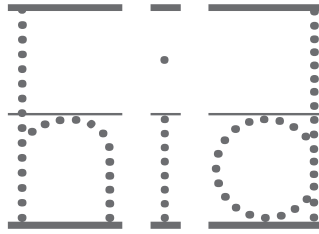
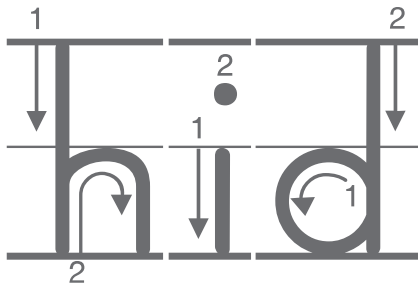

hid hid hid hid hid

-----  
-----  
-----  
-----

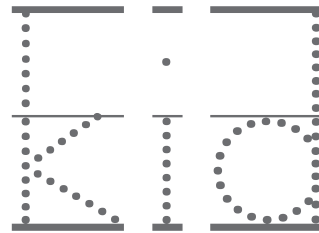
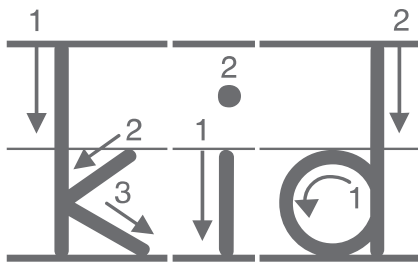

kid kid kid kid kid

-----  
-----  
-----  
-----

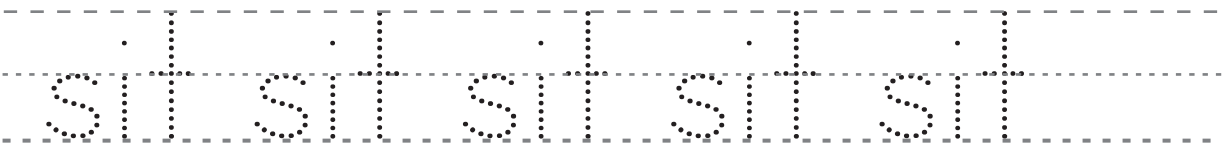
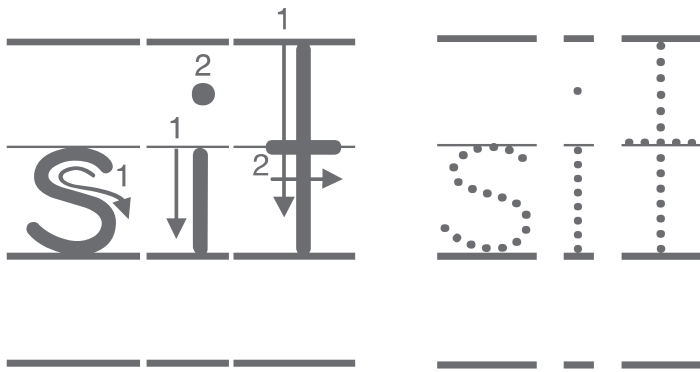
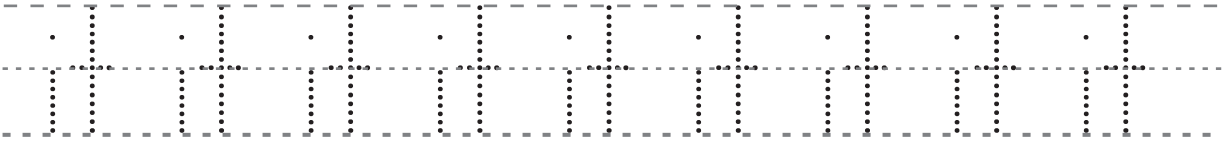
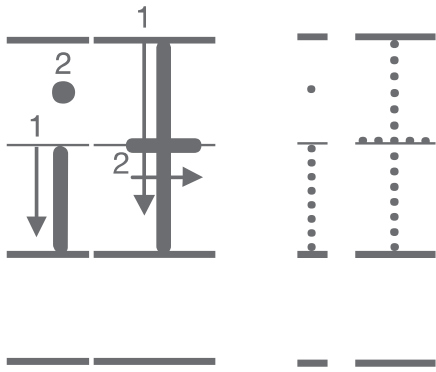

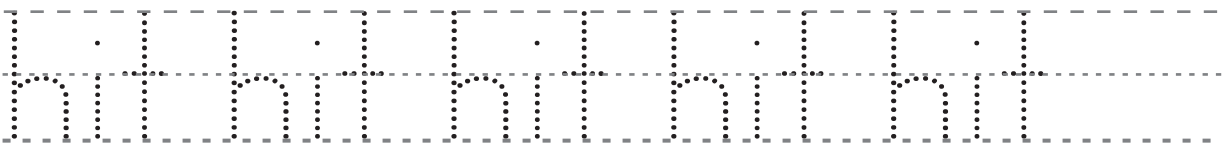
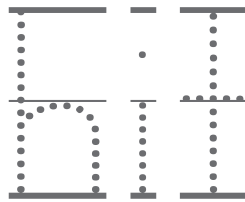
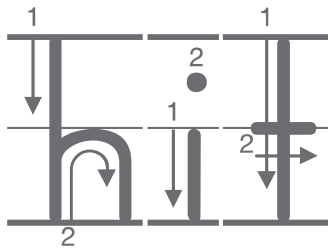
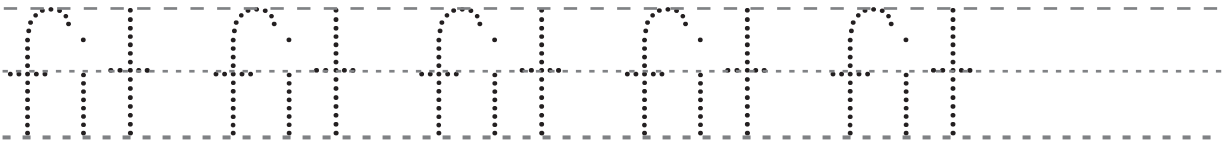
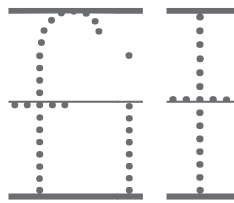
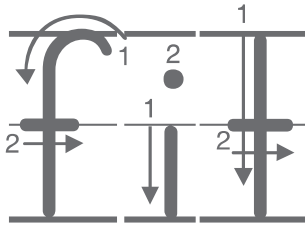

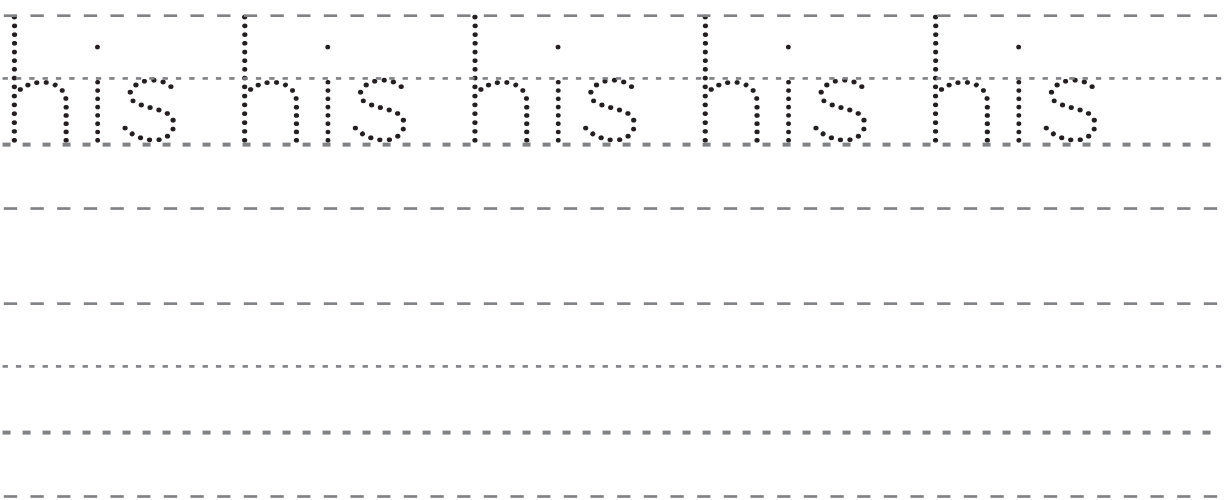
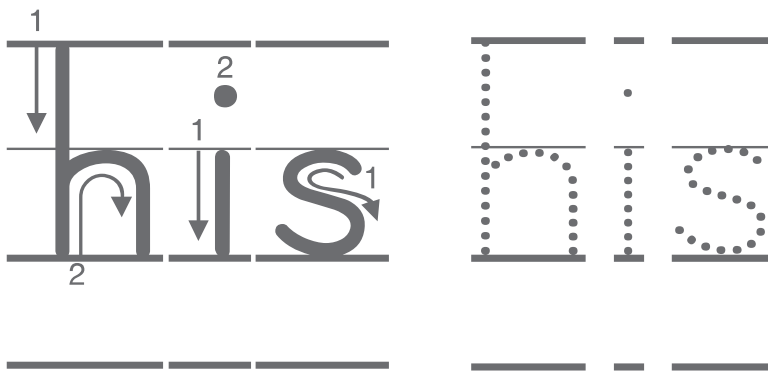
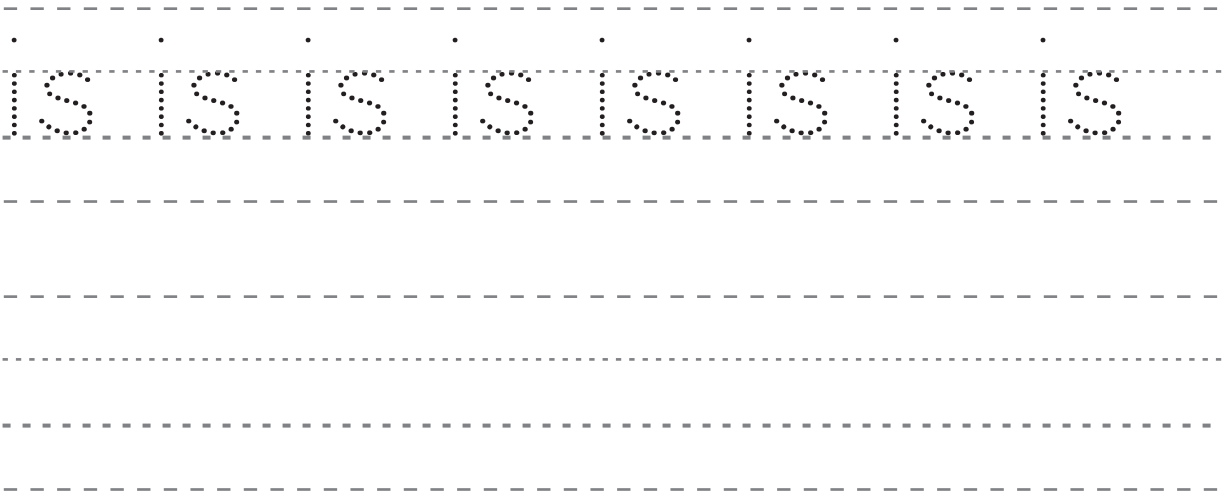
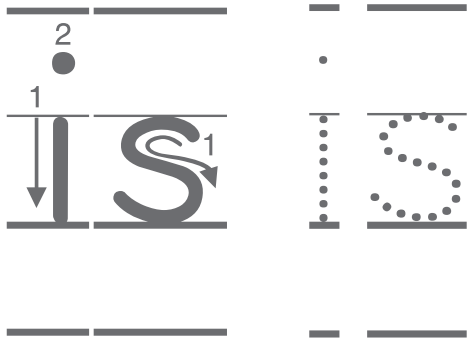

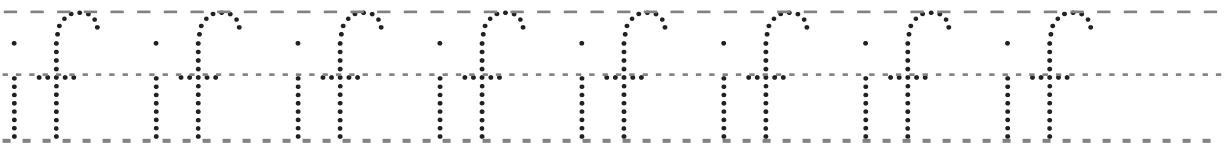
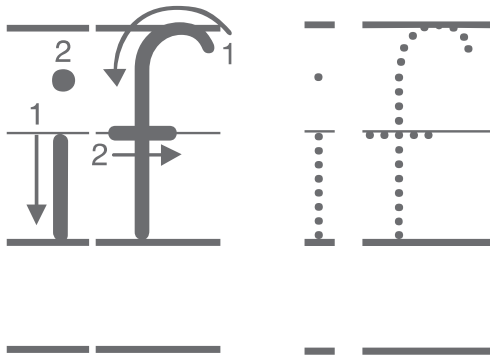
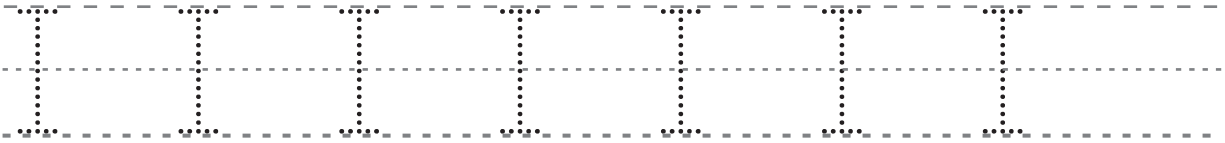
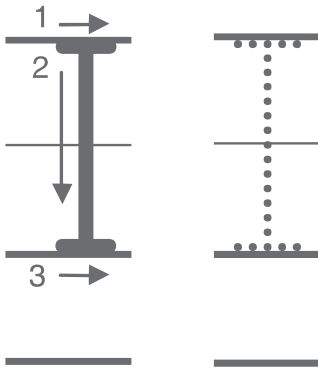

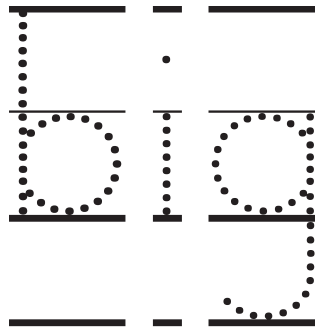
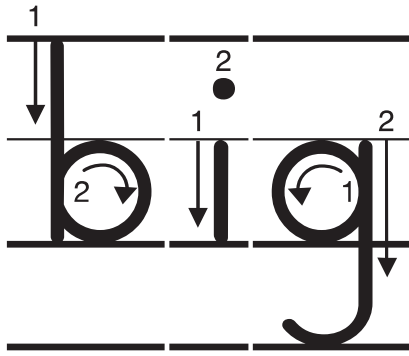

big big big big big

-----  
-----  
-----

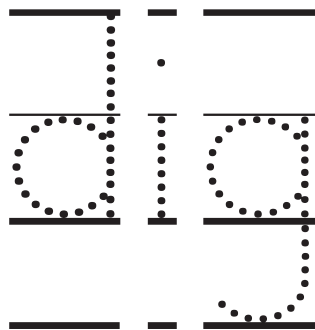
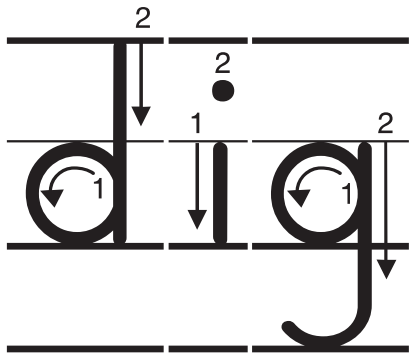

dig dig dig dig dig

-----  
-----  
-----



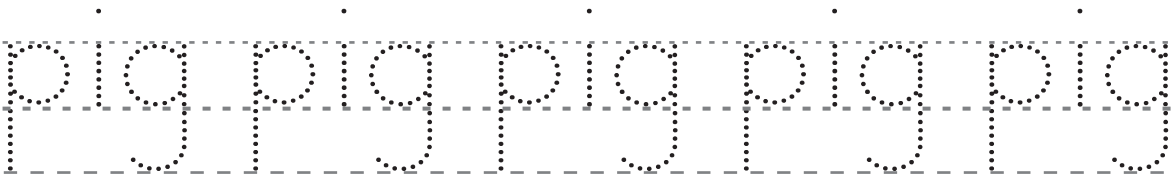
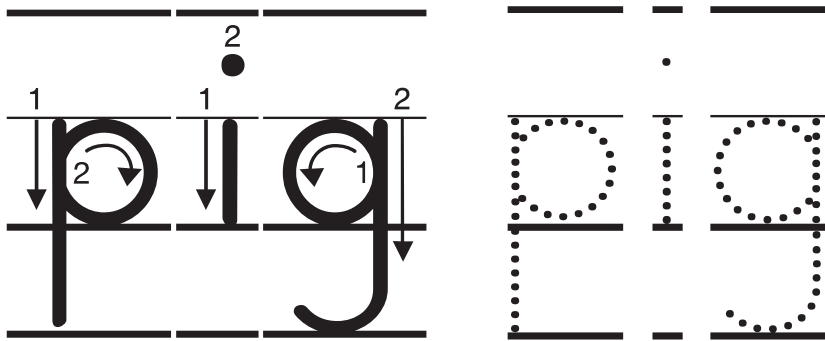
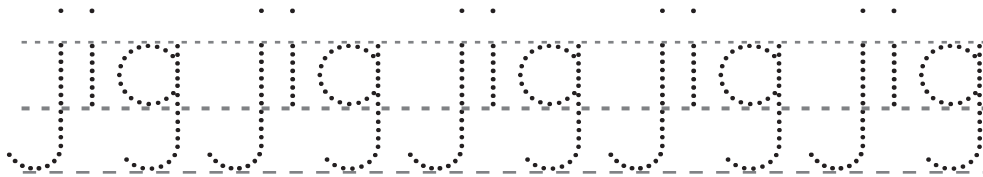
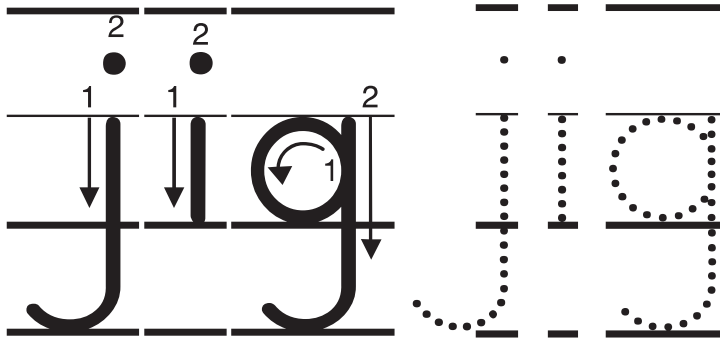

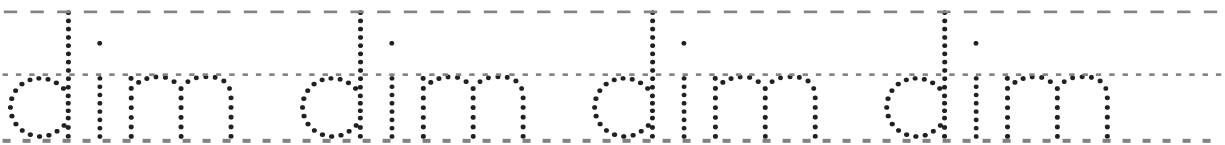
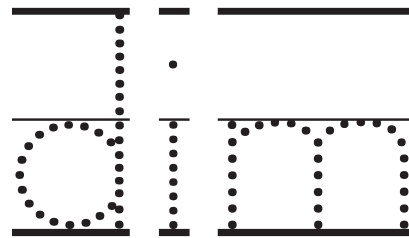
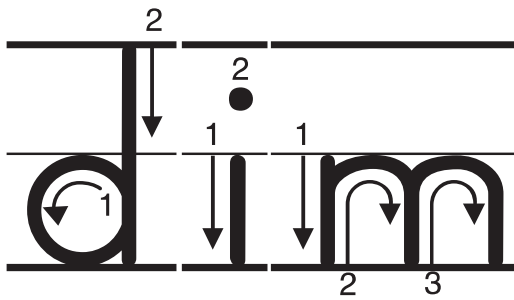
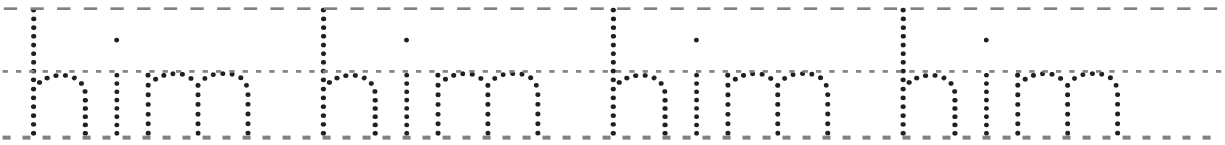
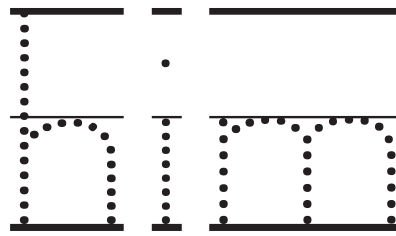
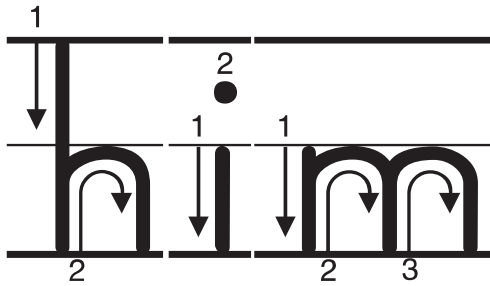

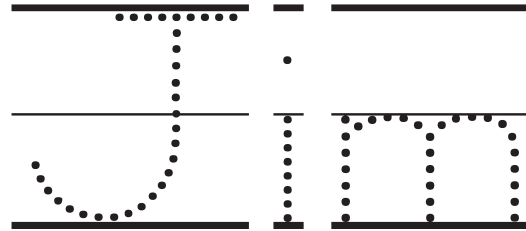
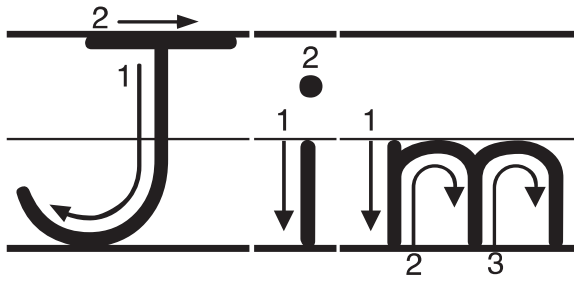
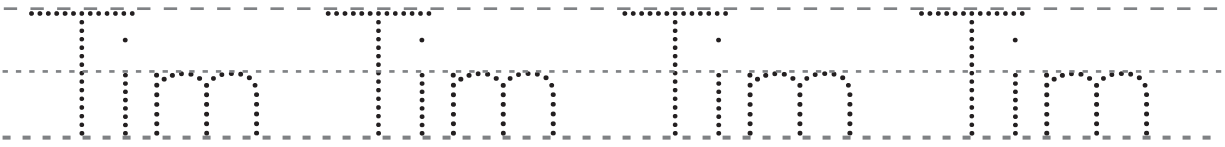
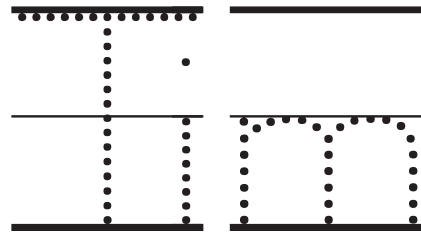
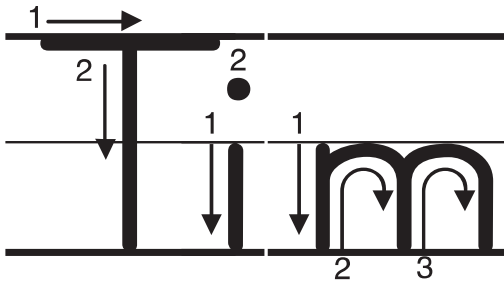

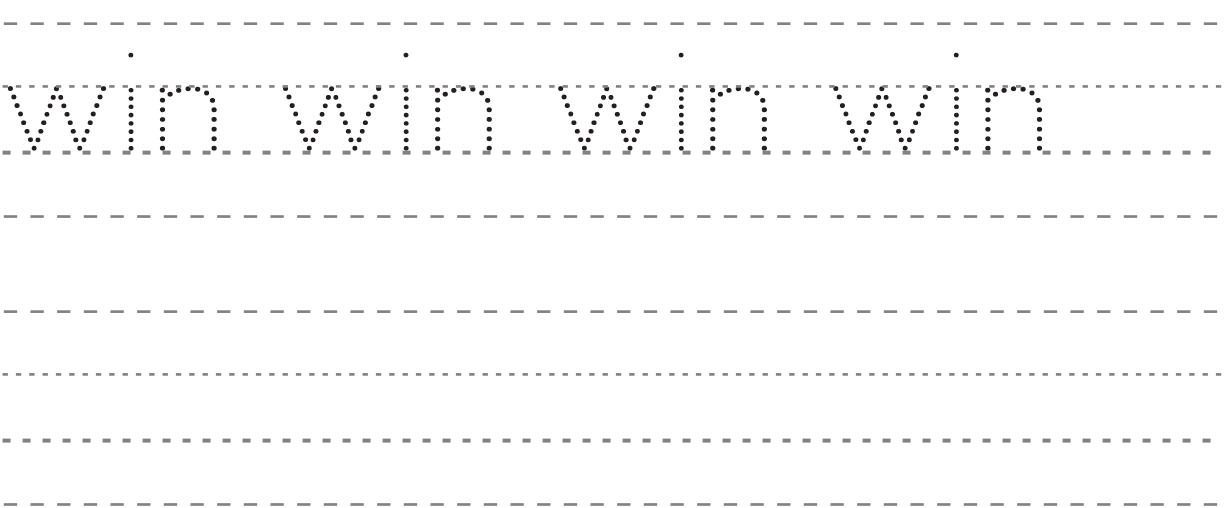
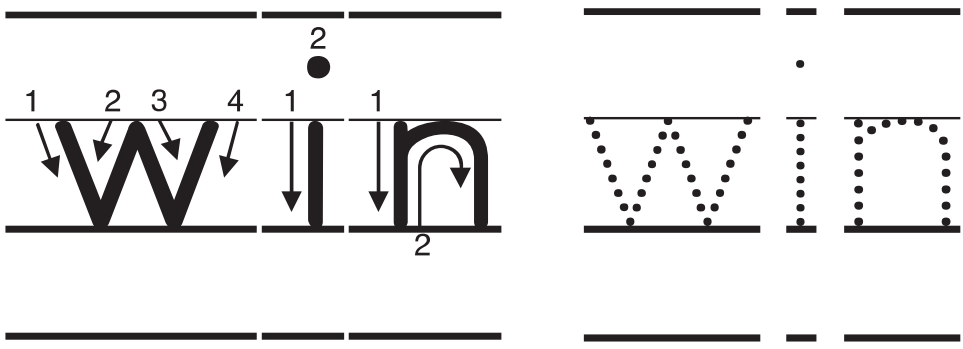
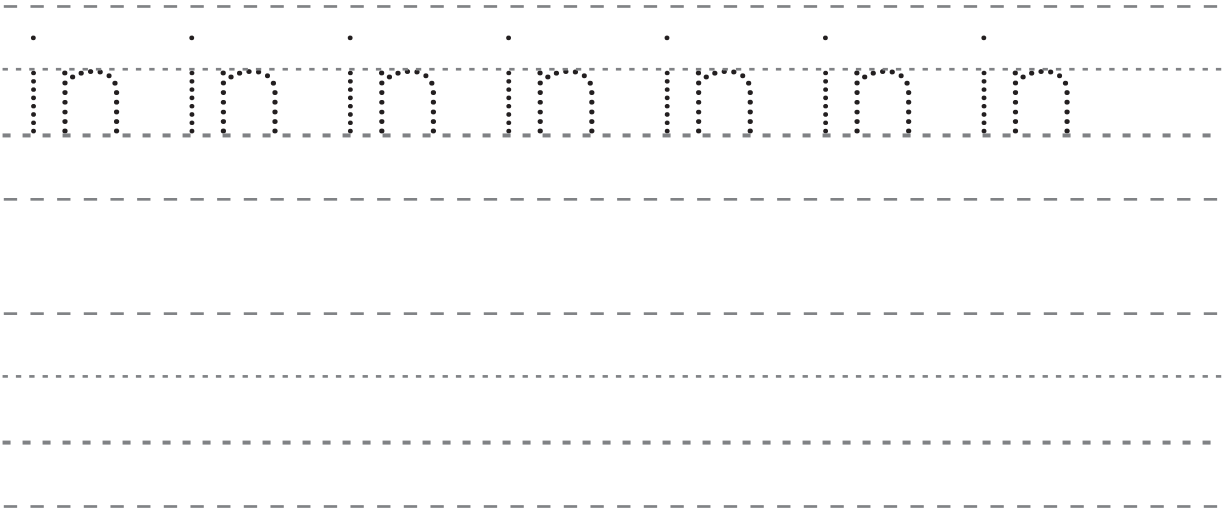
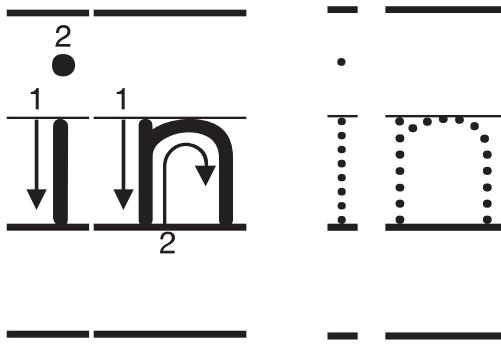

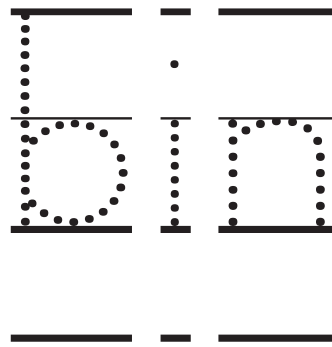
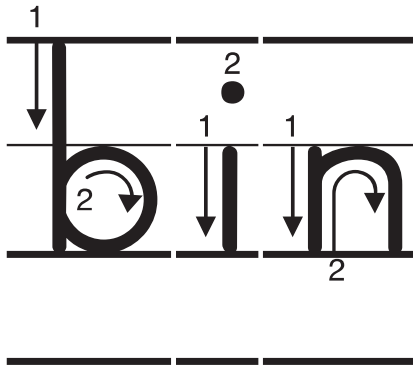

bin bin bin bin

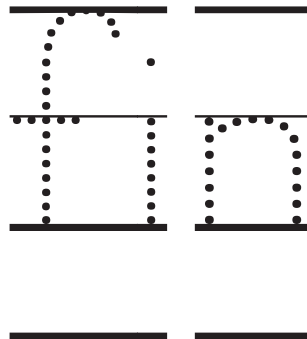
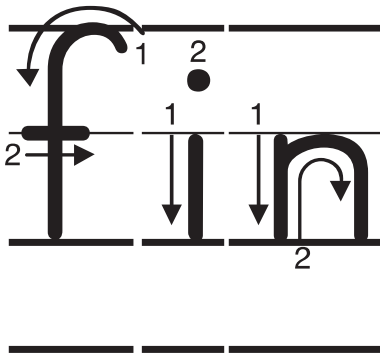

fin fin fin fin

